







**PORTELLA RETTANGOLARE apertura esterna**

-  RECTANGULAR manwaydoor outwards opening
-  Porte RECTANGULAIRE avec ouverture à l'extérieur
-  Puerta RECTANGULAR de apertura externa
-  RECHTECKIGE Türchen, Aussenöffnung
-  ПРЯМОУГОЛЬНАЯ КРЫШКА с внешним открытием
-  外开长方形人孔门

**383L ART**  
275 x 365 mm  
Rev 1

COPERCHIO COVER	<b>C</b>
TELAIO FRAME	<b>T</b>
BRACCIO ARM	<b>B</b>
VOLANTINO HANDWHEEL	<b>V</b>
GUARNIZIONE GASKET	<b>G</b>

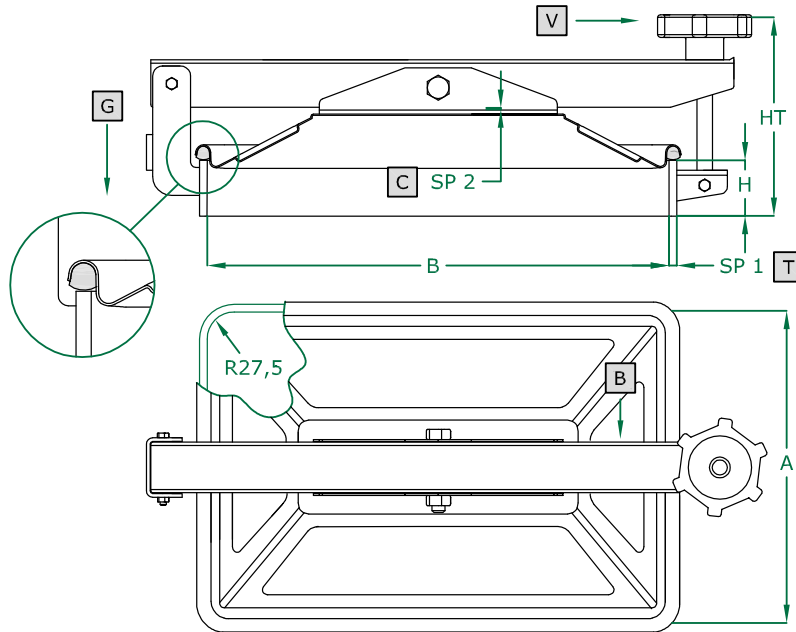

	STANDARD		OPTIONAL			
H X SP1	50 X 6		100 X 6			
TELAIO	SAT		MPL			
GUARNIZIONE	PARA	EPDM	NEOPRENE	NBR	SILICONE	VITON
VOLANTINO	125 001 V NYLON	125 021 V NYLON	125 022 CHROME P.	125 023 S. STEEL	125 024 ALUMINIUM	125 031 S. STEEL

ART	A	B	SP2	HT (standard)	BAR max: (standard)	COVER type:	GASKET code:	KG (standard)
383L	275	365	1,0	175	0,3	CN	120 617	6,0

Технические характеристики указаны для ознакомления. Производитель оставляет за собой право на изменение технических характеристик в одностороннем порядке.